

LINE DRAWING NOT FOR PRODUCTION PURPOSES

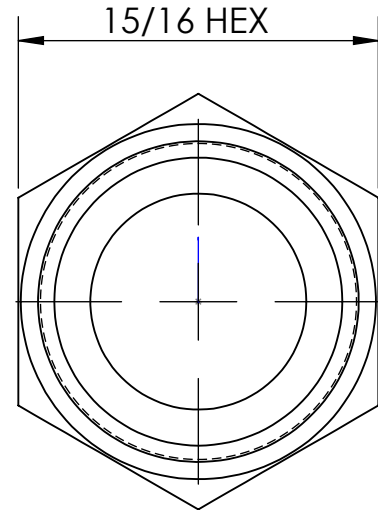

(THRU HOLE DIA.) $\phi 0.56$

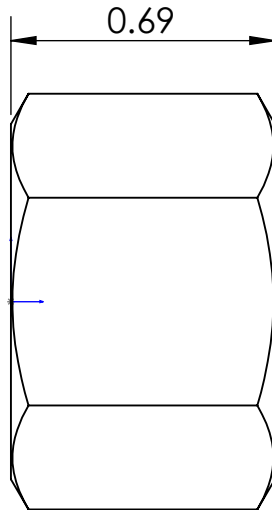
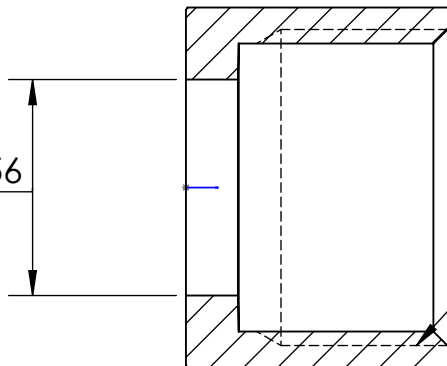

1/2 - 14 NPSM
THREAD

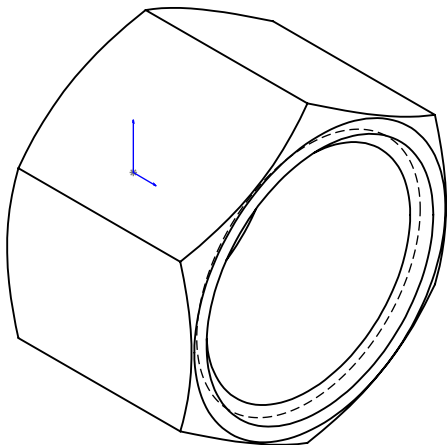

THIS DRAWING CONTAINS INFORMATION DEEMED PROPRIETARY TO DIXON BRASS AND IS SO TO BE USED ONLY FOR THE PURPOSE FOR WHICH IT IS SUBMITTED, AND FURTHER, SHALL NOT BE COPIED IN WHOLE OR IN PART WITHOUT EXPRESS WRITTEN PERMISSION FIRST OBTAINED FROM DIXON BRASS.				
UNLESS OTHERWISE SPECIFIED:		 Dixon Brass Westmont, Illinois USA	DRAWN P. MONAGHAN APPROVED	DATE 2/27/14 DATE
DIMENSIONS ARE IN INCHES TOLERANCES: ANGLES: $\pm 0^{\circ}30'$.X ($\pm .015$) .XX ($\pm .010$) .XXX ($\pm .005$) DIMENSIONS PER ANSI Y14.5			ECO NO.	
TITLE:		DRAWING NOT REPRODUCED TO SCALE		
FEMALE SWIVEL NUT 1/2 - 14 NPSM		SIZE A	DWG. NO. 1240608N	REV D